



ORB

Why are desks rectangular, when much of human culture in terms of shape and form is round? Orb is a revolutionary desking solution that allows the liberalisation of space

through 360 degree circular worktops. Orb desks feature a 4 star cast Aluminium base, Aluminium column with integrated vertical cable

management and an Aluminium cable port with lift off covers. The metalwork is available in White or Black powder coat and the tops can be specified in a choice of standard MFC or MFMDF finishes.

DIMENSIONS

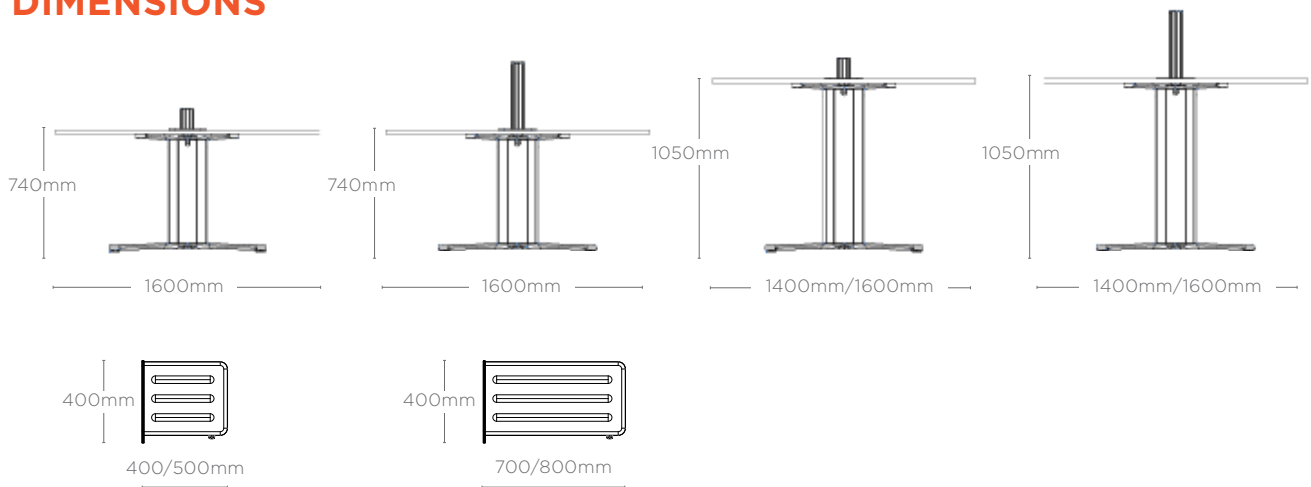

DESIGN

Senator

Our team of talented in house designers are responsible for creating elegant, innovative furniture designs which not only look beautiful, but minimise the impact on the world around us.

They come from all over the world, but are based in our Design Centre located in a quiet Lancashire village just outside the Ribble Valley. Our dedicated facility is over three floors which include studios, a materials test centre and prototyping lab.

Standard Features

- 4 Star cast Aluminium base
- Aluminium extruded column
- Aluminium levelling feet
- 4 Star cast Aluminium top mounting
- Aluminium cable port with lift off covers
- Vertical cable management

Optional Features

- 740mm or 1050mm high
- 1600 dia circular or 1600 dia bite
- 1400 dia circular or 1400 dia bite (1050mm only)
- Full height or low height post
- 25mm MFC top
- 25mm MFMDf top with a ref
- 45. cutback edge profile
- Ply effect contrast edging
- MFMDf edge profile can be stained
- Full screen
- Bite screen
- Above desk mains power/USB power
- Under desk power

Accessories

- CPU holders
- Monitor arms
- Double arm pendant light

Performance Standards

- BS EN 527, Part 1, 2011
- BS EN 527, Part 2, 2016
- BS EN 527, Part 3, 2003
- BS EN 9241 Part 5, 1999
- BS 6396 2012

Round 1600

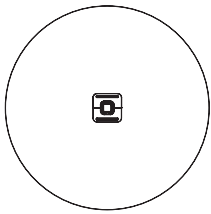

1600mm

Bite 1600

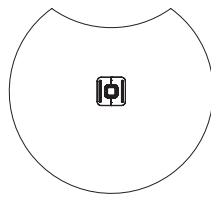

1600mm

Round 1400*

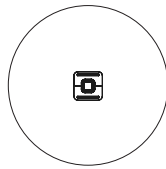

1400mm

Bite 1400*

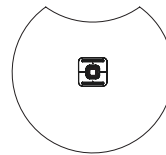

1400mm

*1400 only available on 1050mm height

ACCESSORIES

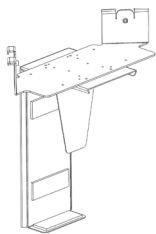

CPU Holder



Dual Light



Monitor Arm

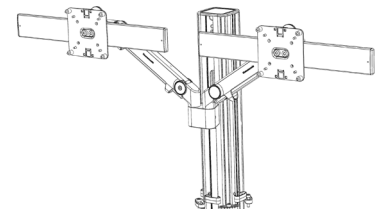

Dual Monitor Arm

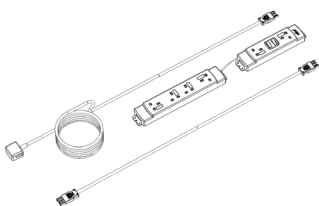

Below Desk Power

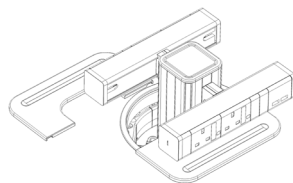

Above Desk Power

ORB

Straight

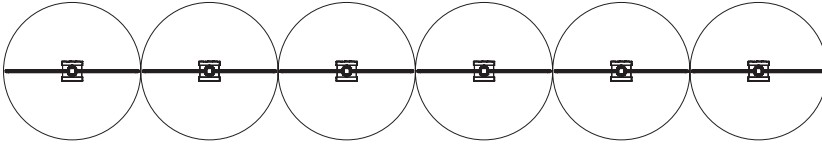

Straight with bite

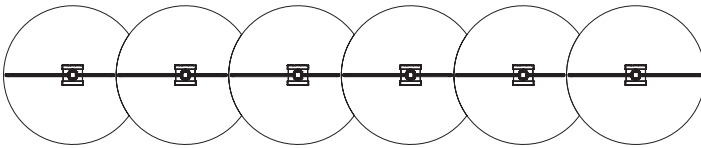

Curve

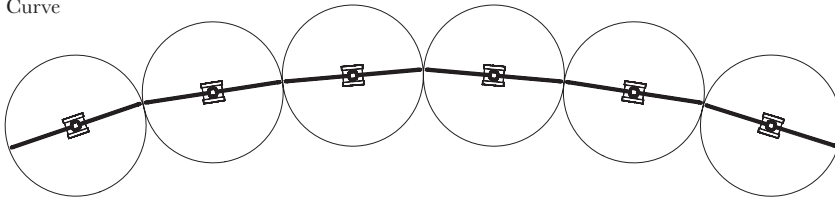

Curve with bite

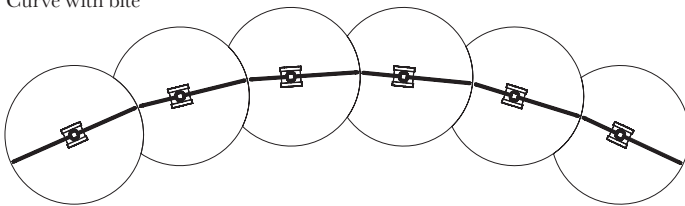

Spine

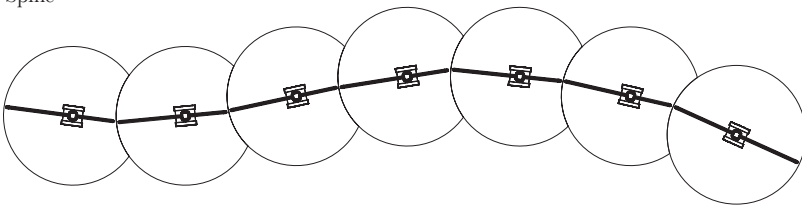

Offset

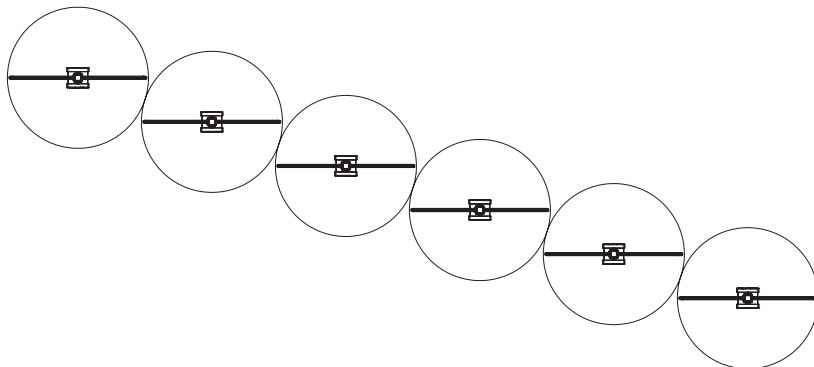

MFC/MFMDF Finishes



Carini Walnut



Mocha



Autumn



Strata Oak



Maple



Highland Oak



Beech



Winter Oak



Hacienda White



White



Light Grey



Denim



Clay*



Bordeaux



Lemon Sorbet

* MFC only

Edge Stains

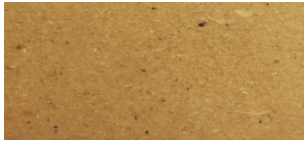

Clear (Standard)



Black

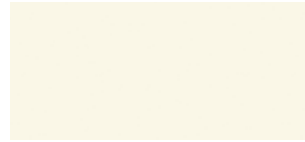

White



Cream



Light Brown

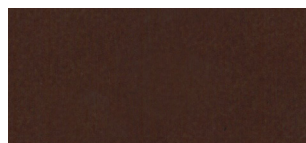

Medium Brown

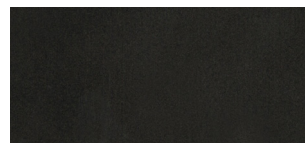

Dark Brown

Contrasting Edge Tapes



Ply Effect Edging

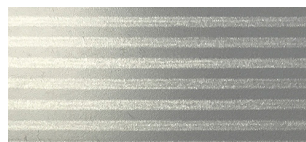

Silvery Ply Edging

All MFCs are available with matching or contrasting edge tape



Ref Group Number 45

25mm MFMDF tops are finished with a 30mm chamfered edge that is clear finished as standard or can be stained as an option.

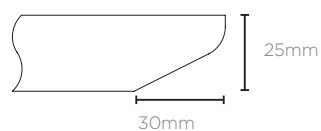

Contrasting Edge Tapes



Black



White

ENVIRONMENTAL

Material Content

Components are constructed of the following

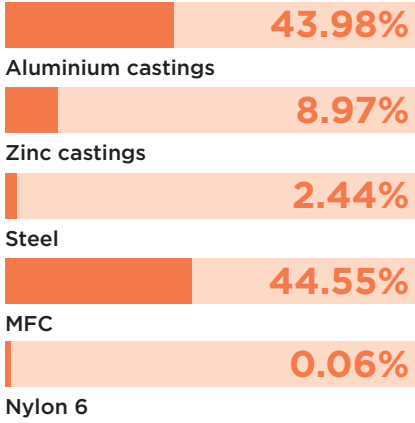

Recycled Content

Contains up to 47% of Recycled Material

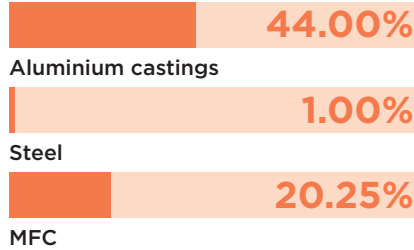

Recyclability

The range is 99% recyclable

99%

SKA Accreditation

EPA's to ISO14025, FSC and FISP accreditation are available for all products on request.

SENATOR 3 R'S

Senator is committed to continually improving the sustainability of all environmental aspects within our business.

To meet both international standards and our own environmental targets we apply the three R's principle

-Reduce, Reuse and Recycle.

Whilst recycling is the element which receives the most exposure it is actually the last option available and should never be the prime target in anyone's battle to reduce waste.

It is our duty as individuals and as a company to initially attempt to **Reduce** usage. Then we should look to **Reuse** wherever possible and finally, only after these two processes have been exhausted, should we consider **Recycling**.

Reduce
Reuse
Recycle